

Article number: 20080384A

Description: E+G T-nut with guide step
GN 506.1-8-M5

Measures

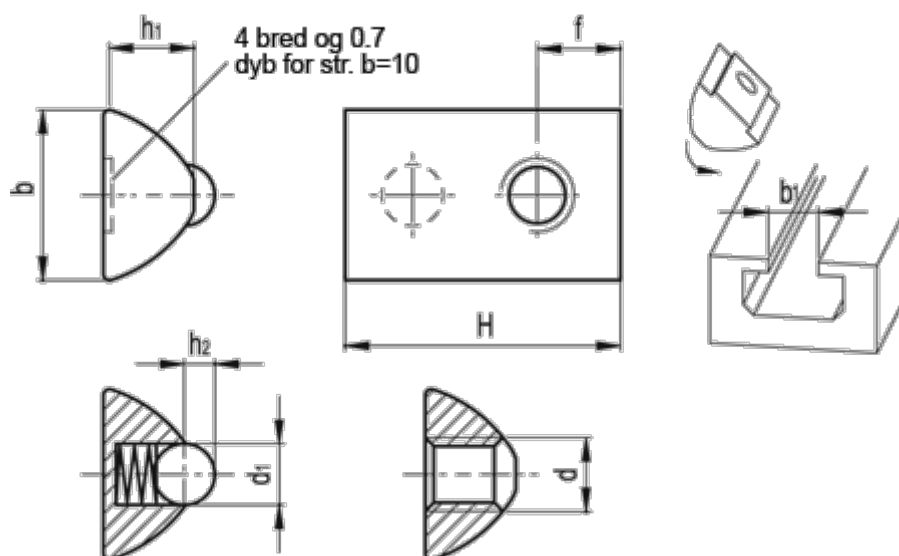

b	= 8 -0.1
b1	= 5
d	= M5
d1	= 3
f	= 4.0
H +0.5	= 12.0
h1	= 4.25
h2	= 0.7

Weight (g) = 2